

# TenuPol-5

Polishing unit

Instruction Manual

**Original Instructions**



CE

Doc. no.: 14087025-01\_A\_en-us  
Date of release: 2023.03.31

---

**Copyright**

The contents of this manual are the property of Struers ApS. Reproduction of any part of this manual without the written permission of Struers ApS is not allowed.

All rights reserved. © Struers ApS 2023.03.31.

---

# Table of Contents

<b>1 About this manual</b> .....	<b>5</b>
1.1 Accessories and consumables .....	5
<b>2 Safety</b> .....	<b>5</b>
2.1 Intended use .....	5
2.2 TenuPol-5 safety precautions .....	6
2.2.1 Read carefully before use .....	6
2.3 Safety messages .....	7
2.4 Safety messages in this manual .....	8
2.5 Working with electrolytes .....	11
2.5.1 Perchloric acid .....	12
<b>3 Getting started</b> .....	<b>16</b>
3.1 Device description .....	16
3.2 Overview - TenuPol-5 .....	17
3.2.1 Control panel functions .....	17
<b>4 Transport and storage</b> .....	<b>18</b>
4.1 Transport .....	18
4.2 Storage .....	18
<b>5 Installation</b> .....	<b>18</b>
5.1 Unpack the machine .....	18
5.2 Check the packing list .....	19
5.3 Location .....	20
5.4 Power supply .....	20
5.4.1 Voltage .....	20
5.5 Connecting the polishing unit .....	21
5.6 Preparing the unit for operation .....	21
5.6.1 Setting up the polishing unit .....	22
5.6.2 Filling the container with electrolyte .....	22
5.6.3 Mounting the jet holders .....	23
<b>6 Maintenance and service</b> .....	<b>23</b>
6.1 Manual functions .....	24
6.1.1 Changing electrolyte .....	24
6.1.2 Cleaning .....	26
6.1.3 Operating the pump manually .....	27
6.2 Daily .....	27

---

6.2.1 Cleaning .....	28
6.2.2 Control unit .....	30
6.3 Monthly .....	30
6.3.1 Calibrating the pump .....	30
6.4 Annually .....	31
6.4.1 Test the safety devices .....	32
6.5 Spare parts .....	32
6.6 Disposal .....	32
6.7 Service and repair .....	33
<b>7 Troubleshooting .....</b>	<b>33</b>
<b>8 Technical data .....</b>	<b>34</b>
8.1 Technical data - TenuPol-5 .....	34
8.2 Noise and vibration levels .....	34
8.3 Safety Circuit Categories/Performance Level .....	34
8.4 Safety Related Parts of the Control System (SRP/CS) .....	35
8.5 Diagrams .....	35
8.5.1 Diagrams - TenuPol-5 .....	35
8.6 Legal and regulatory information .....	39
<b>9 Manufacturer .....</b>	<b>39</b>
<b>Declaration of Conformity .....</b>	<b>41</b>

# 1 About this manual

**CAUTION**

Struers equipment must only be used in connection with and as described in the Instruction Manual supplied with the equipment.

**Note**

Read the Instruction Manual carefully before use.

**Note**

If you wish to view specific information in detail, see the online version of this manual.

## 1.1 Accessories and consumables

### Accessories

For information about the available range, see the TenuPol-5 brochure:

- [The Struers Website](http://www.struers.com) (<http://www.struers.com>)

### Consumables

The equipment is designed to be used only with Struers consumables specifically designed for this purpose and this type of machine.

Other products may contain aggressive solvents, which dissolve e.g. rubber seals. The warranty may not cover damaged machine parts (e.g. seals and tubes), where the damage can be directly related to the use of consumables not supplied by Struers.

For information about the available range, see:

- [The Struers Consumables Catalogue](https://www.struers.com) (via <https://www.struers.com>)

# 2 Safety

## 2.1 Intended use

The unit is intended to be used in combination with:

- TenuPol-5 Control unit

The machine is for use in a professional working environment (e.g. a materialographic laboratory).

TenuPol-5 is designed to perform automatic electrolytic thinning of specimens.

The equipment is intended for use in quality control applications, where the surface can be prepared for further materialographic inspection with a transmitted electron microscope (TEM).

The equipment is designed for preparation of conductive materials suitable for electrolytic etching.

In order for the equipment to operate correctly and safely, it must be used with Struers accessories and consumables specially designed for this purpose and this type of device.

When in use, the machine equipment must not be touched, moved or tampered with.

The operator must be fully instructed in how to handle and use electrolytes with this machine.

The machine must be operated only by skilled/trained personnel.

The machine must be connected to a cooling unit in order to function as intended.

The polishing unit must be placed on an even surface.

The polishing unit must be placed in a well ventilated area, preferably a fume cabinet.

### Control unit

See the Instruction Manual for this unit.

### Do not use the machine for the following

Preparation of materials other than materials suitable for materialographic studies.

The machine must not be used for any type of explosive and/or flammable material, or materials which are not stable during machining, heating or pressure.

Do not use the machine without sufficient ventilation.

The machine must not be used with consumables or a combination of electrolytes and accessories which are not compatible for use with this equipment.

### Model

TenuPol-5

## 2.2 TenuPol-5 safety precautions



### 2.2.1 Read carefully before use

1. Ignoring this information and mishandling of the equipment can lead to severe bodily injuries and material damage.
2. The machine must be installed in compliance with local safety regulations. All functions on the machine and any connected equipment must be in working order. The machine must be earthed (grounded).
3. The operator must read the safety precautions and Instruction Manual, as well as relevant sections of the manuals for any connected equipment and accessories.
4. The operator must be fully instructed in how to handle and use electrolytes with this machine.
5. Follow all safety requirements for handling, mixing, emptying and disposing of electrolytes.

6. The machine must be placed in a well-ventilated location. If needed, you can also place it in a fume cabinet.
7. The machine must be placed on a safe and stable table with an adequate working height.
8. The device is designed to be used with Struers consumables specially designed for this purpose and this type of device.
9. The machine is designed to be used with electrolytes recommended by Struers. Electrolytes that are not recommended by Struers can be dangerous to the operator or harm the machine.
10. Danger of chemical burns. Follow all safety requirements for handling, mixing, emptying and disposing of electrolytes.
11. Many electrolytes contain alcohol or other flammable solvents. Always follow all safety precautions when working with these types of electrolyte.
12. Never try to open the polishing unit while it is running.
13. Do not use the pump without having electrolyte or water in the electrolyte container.
14. Struers recommends that the cooling water supply is shut off or disconnected if the machine is to be left unattended.
15. Always use goggles, gloves and other recommended protective clothing.
16. Accessories: Only use accessories specifically developed for use with this type of machine.
17. If you observe malfunctions or hear unusual noises, switch off the machine and call technical service.
18. Always switch off the electrical power supply and remove the plug or power cable before dismantling the machine or installing additional components.
19. Make sure that the actual electrical power supply voltage corresponds to the voltage stated on the type plate of the machine.
20. The machine must be disconnected from the electrical power supply before any service. Wait 5 minutes until residual potential on the capacitors is discharged.
21. Struers equipment must only be used in connection with and as described in the Instruction Manual supplied with the equipment.
22. If the equipment is subjected to misuse, incorrect installation, alteration, neglect, accident or incorrect repair, Struers will accept no responsibility for damage to the user or the equipment.
23. Dismantling of any part of the equipment, during service or repair, should always be performed by a qualified technician (electromechanical, electronic, mechanical, pneumatic, etc.).

## 2.3 Safety messages

Struers uses the following signs to indicate potential hazards.



### **ELECTRICAL HAZARD**

This sign indicates an electrical hazard which, if not avoided, will result in death or serious injury.



**DANGER**

This sign indicates a hazard with a high level of risk which, if not avoided, will result in death or serious injury.



**WARNING**

This sign indicates a hazard with a medium level of risk which, if not avoided, could result in death or serious injury.



**CAUTION**

This sign indicates a hazard with a low level of risk which, if not avoided, could result in minor or moderate injury.



**CRUSHING HAZARD**

This sign indicates a crushing hazard which, if not avoided, could result in minor, moderate or serious injury.



**HEAT HAZARD**

This sign indicates a heat hazard which, if not avoided, can result in minor, moderate or serious injury.

**General messages**



**Note**

This sign indicates that there is a risk of damage to property, or a need to proceed with special care.



**Hint**

This sign indicates that additional information and hints are available.

## 2.4 Safety messages in this manual



**WARNING**

Struers equipment must only be used in connection with and as described in the Instruction Manual supplied with the equipment.



**WARNING**

Follow all safety requirements for handling, mixing, emptying and disposing of electrolytes.



**WARNING**

Danger of chemical burns.  
Follow all safety requirements for handling, mixing, emptying and disposing of electrolytes.



**CAUTION**

Always request and read the Safety Data Sheet for each electrolyte before you start working with it.

**CAUTION**

Many electrolytes contain alcohol or other flammable solvents. Always follow all safety precautions when working with these types of electrolyte.

**CAUTION**

The operator must be fully instructed in how to handle and use electrolytes with this machine.

**CAUTION**

The machine is designed to be used with electrolytes recommended by Struers. Electrolytes that are not recommended by Struers can be dangerous to the operator or harm the machine.

**CAUTION****Fire and explosion hazards**

- 60% perchloric acid is a very corrosive and oxidizing product. Heating it can cause an explosion, and contact with combustible materials can cause fire.
- Fire fighting must be carried out from a protected location. Use extinguishing media as specified in the Safety Data Sheet.

**CAUTION**

All persons involved in mixing, using, storing, transporting and disposing of electrolytes must be trained in how to handle perchloric acid when carrying out these tasks.

- Do not inhale any vapor from the solution or its components.
- Avoid skin contact.

**WARNING**

Always wear a full-face shield or splash goggles, rubber gloves and a laboratory coat or coveralls when you are working with perchloric acid.

**WARNING**

Make sure that you are mixing the solvent in a chemical-fume hood designed for perchloric acid use.

**WARNING**

Do not use combustible or carbonaceous containers, reaction vessels, spill pans, storage shelves or similar materials when you work with perchloric acid.



**CAUTION**

Do not produce anhydrous perchloric acid, either from its salts or from aqueous solutions, e.g. by heating with high boiling acids or dehydrating agents such as sulfuric acid or phosphorous pentoxide. In addition to spontaneous explosion, the anhydrous acid explodes instantaneously on contact with oxidizable organic materials.



**CAUTION**

Limit the use or storage of perchloric acid to quantities less than 500 g per fume hood.



**CAUTION**

Never turn the polishing unit upside down, particularly if there is electrolyte in the pump.



**CRUSHING HAZARD**

Take care of your fingers when handling the machine.



**ELECTRICAL HAZARD**

The machine must be earthed (grounded).  
Switch off the electrical power supply before installing electrical equipment.  
Make sure that the actual electrical power supply voltage corresponds to the voltage stated on the type plate of the machine.  
Incorrect voltage can damage the electrical circuit.



**ELECTRICAL HAZARD**

**For electrical installations with Residual Current Circuit Breakers**

For this machine a residual current circuit breaker Type B, 30 mA (or better) is recommended is required (EN 50178/5.2.11.1).

**For electrical installations without Residual Current Circuit Breakers**

The equipment must be protected by an insulation transformer (double-wound transformer).

Contact a qualified electrician to verify the solution.

Always follow local regulations.



**CAUTION**

Prolonged exposure to loud noises may cause permanent damage to a person's hearing.  
Use hearing protection if the exposure to noise exceeds the levels set by local regulations.



**CAUTION**

Do not use the machine with non-compatible accessories or consumables.

**CAUTION**

Always use goggles or a protective shield, and chemical-resistant gloves.

**WARNING**

Do not touch, move or tamper with the unit during use.

**WARNING**

Do not use the machine with defective safety devices.  
Contact Struers Service.

**WARNING**

Safety critical components must be replaced after a maximum lifetime of 20 years.  
Contact Struers Service.

**CRUSHING HAZARD**

Take care of your fingers when handling the machine.  
Wear safety shoes when handling heavy machinery.

## 2.5 Working with electrolytes

**WARNING**

Danger of chemical burns.  
Follow all safety requirements for handling, mixing, emptying and disposing of electrolytes.

**CAUTION**

Always request and read the Safety Data Sheet for each electrolyte before you start working with it.

**CAUTION**

Many electrolytes contain alcohol or other flammable solvents. Always follow all safety precautions when working with these types of electrolyte.

**CAUTION**

The operator must be fully instructed in how to handle and use electrolytes with this machine.

**CAUTION**

The machine is designed to be used with electrolytes recommended by Struers. Electrolytes that are not recommended by Struers can be dangerous to the operator or harm the machine.



**CAUTION**

Many electrolytes contain alcohol or other flammable solvents. Make sure that all safety precautions are followed for these types of electrolytes.

**Availability**

Struers electrolytes are not marketed in the USA. If needed, the chemical compounds for the electrolyte must be purchased independently.

Contact your Struers representative for further information.

**After use**

Do not let the electrolyte dry or crystallize inside the machine or on the polished material.

**Disposal**

See [Disposal](#) ► 32.

**2.5.1 Perchloric acid**



**CAUTION**

Always request and read the Safety Data Sheet for each electrolyte before you start working with it.

To find the Safety Data Sheet for the components in question, see: [www.struers.com](http://www.struers.com).



**CAUTION**

**Fire and explosion hazards**

- 60% perchloric acid is a very corrosive and oxidizing product. Heating it can cause an explosion, and contact with combustible materials can cause fire.
- Fire fighting must be carried out from a protected location. Use extinguishing media as specified in the Safety Data Sheet.

**Training**



**CAUTION**

All persons involved in mixing, using, storing, transporting and disposing of electrolytes must be trained in how to handle perchloric acid when carrying out these tasks.

- Do not inhale any vapor from the solution or its components.
- Avoid skin contact.

**Mixing perchloric acid into the electrolyte solution**

If you are working with Struers electrolytes marked with the prefix A, you must mix a certain amount of perchloric acid into the electrolyte solution.

**WARNING**

Always wear a full-face shield or splash goggles, rubber gloves and a laboratory coat or coveralls when you are working with perchloric acid.

**WARNING**

Make sure that you are mixing the solvent in a chemical-fume hood designed for perchloric acid use.

**WARNING**

Do not use combustible or carbonaceous containers, reaction vessels, spill pans, storage shelves or similar materials when you work with perchloric acid.

**WARNING**

For information about electrolytes, see the Safety Data Sheet for the specific product.

**Procedure****CAUTION**

The components must be used in the correct quantity as specified below.

Electrolyte A2		
1. Mix ethanol, butoxyethanol and water. 2. Immediately before use, add A2 II - perchloric acid to the A2 I mixture.		
Formula	A2 I	A2 II
	90 ml distilled water 730 ml ethanol 100 ml butoxyethanol	78 ml perchloric acid
Chemicals	All chemicals are chemically pure, preferably analytical grade. Per cent is, where no other is stated, weight per cent.	
	Butoxyethanol	Ethylene glycol monobutyl ether, CH <sub>3</sub> -(CH <sub>2</sub> ) <sub>2</sub> -CH <sub>2</sub> -O-CH <sub>2</sub> -CH <sub>2</sub> OH
	Ethanol 96% vol	CH <sub>3</sub> -CH <sub>2</sub> OH
	Perchloric acid	60%, HClO <sub>4</sub>
	Distilled water	H <sub>2</sub> O

Electrolyte A2	
<b>Health and Safety</b>	
Before mixing, read the MSDS thoroughly for the specific components.	
The user must follow the instructions for proper work procedure according to the instruction manual supplied with the equipment.	
	<b>Note</b> The product must be disposed of according to local regulations for dangerous goods.

Electrolyte A3		
1. Mix ethanol and butoxyethanol.		
2. Immediately before use, add A3 II - perchloric acid to the A3 I mixture.		
<b>Formula</b>	<b>A3 I</b>	<b>A3 II</b>
	600 ml methanol	60 ml perchloric acid
	360 ml butoxyethanol	
<b>Chemicals</b>	All chemicals are chemically pure, preferably analytical grade. Per cent is, where no other is stated, weight per cent.	
	Butoxyethanol	Ethylene glycol monobutyl ether, CH <sub>3</sub> -(CH <sub>2</sub> ) <sub>2</sub> -CH <sub>2</sub> -O-CH <sub>2</sub> -CH <sub>2</sub> OH
	Methanol	100% vol., CH <sub>3</sub> OH
	Perchloric acid	60%, HClO <sub>4</sub>
<b>Health and Safety</b>		
Before mixing, read the MSDS thoroughly for the specific components.		
The user must follow the instructions for proper work procedure according to the instruction manual supplied with the equipment.		
	<b>Note</b> The product must be disposed of according to local regulations for dangerous goods.	

Electrolyte D2		
1. Mix the phosphoric acid <b>in</b> the distilled water 2. Add ethanol, propanol and urea.		
<b>Formula</b>	<b>D2</b>	
	500 ml distilled water	
	250 ml phosphoric acid	
	250 ml ethanol	
	50 ml propanol	
	5 g urea	
<b>Chemicals</b>	All chemicals are chemically pure, preferably analytical grade. Per cent is, where no other is stated, weight per cent.	
	Ethanol	96% vol., CH <sub>3</sub> -CH <sub>2</sub> OH
	Phosphoric acid	Ortho phosphoric acid 85%, (HO) <sub>3</sub> PO
	Propanol	2-propanol 100%, CH <sub>3</sub> -CH <sub>2</sub> -CH <sub>2</sub> OH
	Urea	CO(NH <sub>2</sub> ) <sub>2</sub>
	Distilled water	H <sub>2</sub> O
<b>Health and Safety</b>		
Before mixing, read the MSDS thoroughly for the specific components.  The user must follow the instructions for proper work procedure according to the instruction manual supplied with the equipment.		
<div style="border: 1px solid blue; border-radius: 10px; padding: 10px;">  <p><b>Note</b> The product must be disposed of according to local regulations for dangerous goods.</p> </div>		

### Storing perchloric acid or solution



#### CAUTION

Do not produce anhydrous perchloric acid, either from its salts or from aqueous solutions, e.g. by heating with high boiling acids or dehydrating agents such as sulfuric acid or phosphorous pentoxide. In addition to spontaneous explosion, the anhydrous acid explodes instantaneously on contact with oxidizable organic materials.



#### CAUTION

Limit the use or storage of perchloric acid to quantities less than 500 g per fume hood.

- Never let perchloric acid crystallize on bottle necks, caps or anywhere else.

4. Store the chemical in a secure, cool, and well-ventilated area with a metal, glass or ceramic spill catch pan.
5. Store the chemical away from other chemicals or combustible or organic materials.
6. Never let solutions dry out.

For more information, see the Safety Data Sheet for the product.

## 3 Getting started

### 3.1 Device description

The equipment is used for materialographic preparation which enables further examination of materials for quality control purposes. It is designed for fast preparation of specimens suitable for transmission electron microscopy (TEM).

Electrolytical thinning can be performed on most metallic material surfaces. The electrochemical process is possible on electrically conductive materials by the action of electrolyte and electricity. During the process, a high, local current, which is applied to the area of the specimen covered with electrolytes, will have an etching effect on the surface. This process makes the surface suitable for further materialographic analysis.

The equipment consists of a control unit and a polishing unit.

The polishing unit must be placed in a well ventilated area, preferably a fume cabinet, to prevent inhalation of hazardous vapors.

The operator fills and empties the electrolyte container in the polishing unit.

Before starting the process, the operator places a specimen/sample/workpiece in the specimen holder/sample holder. The operator selects a suitable method, accessory, and electrolyte. There are 200 predefined polishing/thinning methods for pre-thinning and final thinning.

The operator makes sure that a suitable combination of electrolytes and polishing parameters is selected for the material. The operator makes sure that the correct electrolyte is in the polishing unit.

The operator starts the process. A scanning function automatically determines the correct polishing voltage for the thinning process. Small layers of material are removed from both sides of the specimen in the electrolytic etching/thinning process. During the process, current and electrolyte temperature are shown on the screen.

The voltage and current are monitored and adjusted automatically. In case of excess heat and/or excess power consumption the unit switches off automatically.

The polishing/thinning process stops automatically when a hole appears in the specimen.

After use, the electrolyte container must be emptied and cleaned with water. The electrolyte must be stored in a safe location in a closed container suitable for the purpose. Cleaning is carried out by using the electrolyte container filled with water.



**Note**

Proper maintenance is required to achieve the maximum up-time and operating lifetime of the machine.

**Note**

The device is designed to be used with Struers consumables specially designed for this purpose and this type of device.

## 3.2 Overview - TenuPol-5

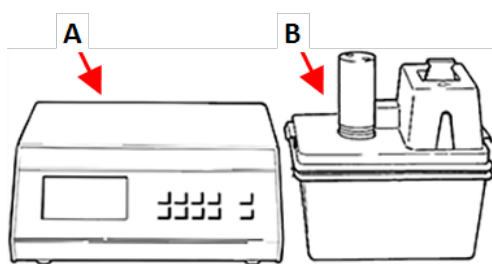

- A Control unit
- B Polishing unit

### Polishing unit

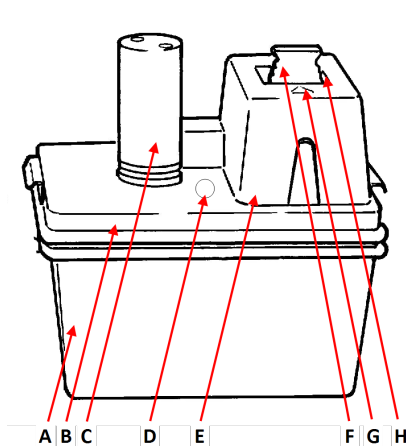

### Front view - Polishing unit

- A Electrolyte container, insulated
- B Base plate
- C Pump
- D Opening for thermometer
- E Protective cover
- F Specimen holder
- G Polishing cell
- H Jet holder

### Control unit

See the manual supplied with the specific equipment.

### 3.2.1 Control panel functions

There is no control panel on the TenuPol-5 polishing unit.

The unit is controlled from the TenuPol-5 control unit. See the manual supplied with the specific equipment.

## 4 Transport and storage

If, at any time after the installation, you have to move the unit or place it in storage, there is a number of guidelines we recommend that you follow.

- Package the unit securely before transportation. Insufficient packaging could cause damage to the unit and will void the warranty. Contact Struers Service.
- We recommend that you use the original packaging and fittings.

### 4.1 Transport

1. Clean the polishing unit thoroughly. See [Cleaning ▶ 28](#).
2. Disconnect the electrical power supply.
3. Disconnect the polishing unit from the water supply or the cooling unit (option).
4. Move the unit to its new position.

### 4.2 Storage



**Note**

We recommend that you keep all original packaging and fittings for future use.

- Disconnect the unit from the electrical power supply.
- Disconnect the unit from the water supply.
- Remove any accessories.
- Clean and dry the unit before storage. See [Daily ▶ 27](#).
- Place the machine and accessories in their original packaging.
- Place a bag of desiccant (silica gel) in the box.
- For details on storage temperature and humidity, see [Technical data - TenuPol-5 ▶ 34](#).

**Control unit**

See the Instruction Manual for this unit.

## 5 Installation

### 5.1 Unpack the machine



**Note**

We recommend that you keep all original packaging and fittings for future use.

The equipment is delivered in two boxes.

- Control unit
- Polishing unit

### Polishing unit

1. Cut the packing tape on the top of the box.
2. Remove the loose parts.
3. Remove the unit from the box.

### Control unit

See the Instruction Manual for this unit.

### Moving the machine

See [Transport ► 18](#).

## 5.2 Check the packing list

The equipment is delivered in two boxes.

- Control unit
- Polishing unit

Optional accessories may be included in the packing box.

### Polishing unit

The packing box contains the following items:

Pcs.	Description
1	Polishing unit
1	Supply and communications cable for connection to the control unit
1	Thermometer pocket
1	Specimen holder. For specimens with a diameter of Ø3 mm
1	Jet holder. Inside diameter: Ø1 mm. Set of 2 pieces
1	Protective cover
1	Electrolyte container, insulated, PVC
1	Electrolyte container, uninsulated, PVC
2	Tube for cooling coil. Diameter: 8 mm. Length: 1 m
1	Jet holder. With ascending tube for calibration
1	Return tube for calibration
1	Instruction Manual set

**Control unit**

See the Instruction Manual for this unit.

### 5.3 Location



**CRUSHING HAZARD**

Take care of your fingers when handling the machine.  
Wear safety shoes when handling heavy machinery.



**WARNING**

The polishing unit must be placed in a well ventilated area, preferably a fume cabinet.  
Do not touch, move or tamper with the unit during use.

- The polishing unit must be placed in a well ventilated area, preferably a fume cabinet.
- Place the unit on a rigid, stable workbench with a horizontal surface and an adequate height. The workbench must be resistant to chemicals.
- Place the unit close to the water supply or to a separate cooling unit.
- The length of the supply and communications cable connecting the two units is 2 m (6.5 ft), so that the units can be placed in separate locations.

**Control unit**

See the Instruction Manual for this unit.

### 5.4 Power supply



**CAUTION**

The machine must be earthed (grounded).  
Switch off the electrical power supply before installing electrical equipment.  
Make sure that the actual electrical power supply voltage corresponds to the voltage stated on the type plate of the machine.  
Incorrect voltage can damage the electrical circuit.

**Control unit**

See the Instruction Manual for this unit.

#### 5.4.1 Voltage



**CAUTION**

The machine must be earthed (grounded).  
Switch off the electrical power supply before installing electrical equipment.  
Make sure that the actual electrical power supply voltage corresponds to the voltage stated on the type plate of the machine.  
Incorrect voltage can damage the electrical circuit.



**Note**

In countries with a 100 - 120 V electrical power supply, you must change the setting

- 115 V: 100-120 V/50/60 Hz
- 230 V: 200-240 V/50/60 Hz Factory setting

### How to change the voltage

1. Use a small, flat-tip screwdriver to open the cover of the fuse compartment at the back of the control unit.
2. Take the fuse out of the fuse compartment.
3. Turn the fuse into the required position.
4. Push it back into the fuse compartment.
5. Close the cover of the fuse compartment.

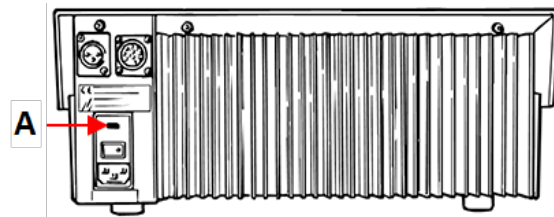

A Fuse compartment

## 5.5 Connecting the polishing unit



### WARNING

The polishing unit must be placed in a well ventilated area, preferably a fume cabinet.  
Do not touch, move or tamper with the unit during use.

1. Connect the cable from the polishing unit to the adapter supplied with the control unit.
2. Connect the adapter cable to the back of the control unit.
3. Tighten the retaining ring to secure the plug.

### Calibrating the pump

The first time the machine is switched on, it is recommended that you adjust the pump. See [Calibrating the pump ► 30](#).

## 5.6 Preparing the unit for operation



### WARNING

The polishing unit must be placed in a well ventilated area, preferably a fume cabinet.  
Do not touch, move or tamper with the unit during use.

### 5.6.1 Setting up the polishing unit

1. Place the base plate with pump and cooling coil on the insulated container.
2. Insert the thermometer, **A**, in the hole between the polishing cell and the pump motor.



#### CAUTION

Always use the thermometer during preparation.

3. Connect one of the tubes supplied with the polishing unit to the cooling coil and to the water supply.
4. Connect the other tube to the other side of the cooling coil and lead it to the drain.
5. If the unit is connected to an external cooling unit (option), use suitable, insulated tubes to connect the cooling unit and the cooling coil.

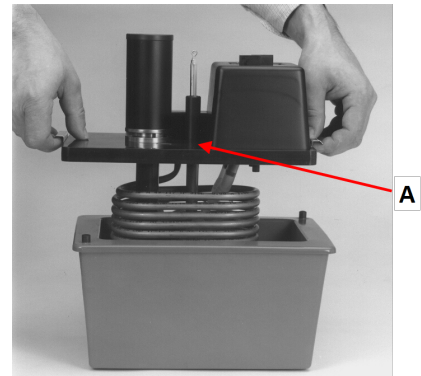

#### Note

See the Instruction Manual for this unit.



#### Hint

If it is not possible to cool the electrolyte with cooling water or an external cooling unit, place the uninsulated container in an ice bath for cooling.

### 5.6.2 Filling the container with electrolyte



#### CAUTION

Always observe the current safety regulations regarding handling and disposal of electrolytes.  
The operator must be fully instructed in how to handle and use electrolytes with this machine.



#### WARNING

Always handle electrolytes in well ventilated areas.  
Always use safety gloves, goggles and a funnel when you handle electrolytes.

For instructions on handling electrolytes, see [Working with electrolytes](#) ► 11.

1. Remove the base plate with the pump and cooling coil from the electrolyte container.
2. Fill the electrolyte container to the mark with electrolyte (approximately 1 l).
3. Place the base plate on the electrolyte container.

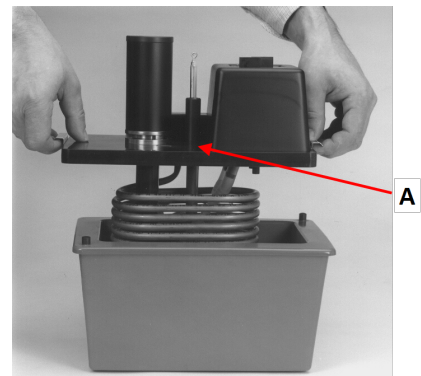

### 5.6.3 Mounting the jet holders

1. Place one jet holder in the polishing chamber and slide the sleeve into the groove until the holder fits tightly against the back wall of the chamber.
2. Mount the other jet in the same way at the other side of the chamber.
3. Connect the two mini jack plugs in the corresponding sockets in the jet holders.
4. Place the protective cover over the polishing chamber.

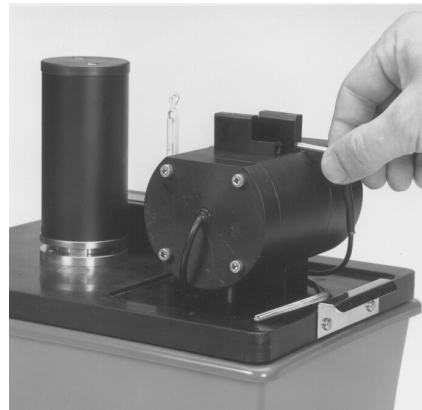

## 6 Maintenance and service

Proper maintenance is required to achieve the maximum up-time and operating lifetime of the machine. Maintenance is important in ensuring continued safe operation of your machine.

The maintenance procedures described in this section must be carried out by skilled or trained personnel.

**Safety Related Parts of the Control System (SRP/CS)**

For specific safety related parts, see the section "Safety Related Parts of the Control System (SRP/CS)" in the section "Technical data" in this manual.

**Technical questions and spare parts**

If you have technical questions or when you order spare parts, state serial number and voltage/frequency. The serial number and the voltage are stated on the type plate of the machine.

## 6.1 Manual functions

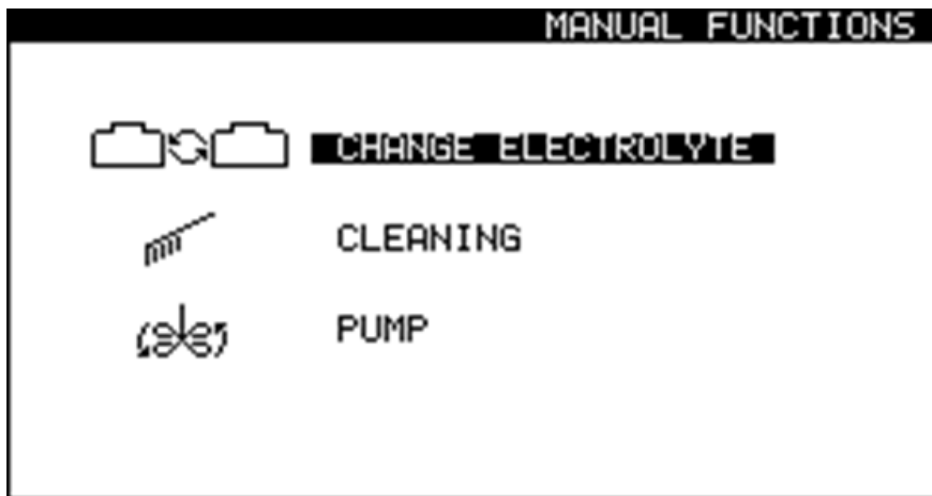

A number of manual functions are available in the software.



1. From the **Main menu** screen, select the **Manual funct.** screen.



From the **Manual Functions** screen you can choose between the following options:

-  • **Change electrolyte.** See [Changing electrolyte ▶ 24](#).
-  • **Cleaning.** See [Cleaning ▶ 28](#).
-  • **Pump.** See [Operating the pump manually ▶ 27](#).

### 6.1.1 Changing electrolyte

When you change from a method that uses one type of electrolyte to a method that uses a different type of electrolyte, you must change the electrolyte. You will be prompted to change the electrolyte and clean the system. If needed, you can start this function manually.



**CAUTION**

Always use goggles or a protective shield, and chemical-resistant gloves.

**WARNING**

Do not touch, move or tamper with the unit during use.

1. From the **Main menu** screen, select the **Manual funct.** screen.



2. From the **Manual Functions** screen, select the **Change electrolyte** screen.



3. Press **Enter** to continue.



4. Follow the on-screen instructions. The on-screen instructions are listed below.

5. Press **Enter** to continue through the sequence of steps.



You can cancel the process at any time. To do so, press **Escape**.



6. The following messages appear.

**[ Remove Electrolyte: ]**

1. **Lift the polishing unit.**
2. **Place it in the container with water**
3. **Remove the present elec.**

**[ Cleaning... ]**

**The system is being cleaned now.**

**Please wait 54s**

**[ Cleaning done ]**

1. **Lift the polishing table.**
2. **Use alcohol to remove water.**
3. **Clean off the remaining alcohol.**

[ Remove water ]

Remove the water.

[ Select new Electrolyte ]

A2

A3

A8

...

10% oxalic

USER 1

### 6.1.2 Cleaning

When you have finished using the machine, you must clean the system.



**CAUTION**

Always use goggles or a protective shield, and chemical-resistant gloves.



**WARNING**

Do not touch, move or tamper with the unit during use.

1. From the **Main menu** screen, select the **Manual funct.** screen.
2. From the **Manual Functions** screen, select the **Cleaning** screen.
3. Press **Enter** to continue.
4. Follow the on-screen instructions. The on-screen instructions are listed below.
5. Press **Enter** to continue through the sequence of steps.



You can cancel the process at any time. To do so, press **Escape**.

6. The following messages appear.

**[ Remove Electrolyte: ]**

1. **Lift the polishing unit.**
2. **Place it in the container with water**
3. **Remove the present elec.**

**[ Cleaning... ]**

**The system is being cleaned now.**

**Please wait 54s**

**[ Cleaning done ]**

1. **Lift the polishing table.**
2. **Use alcohol to remove water.**
3. **Clean off the remaining alcohol.**

**[ Remove water ]**

**Remove the water.**

### 6.1.3 Operating the pump manually

You can activate the pump and adjust the flow rate manually.

1. From the **Main menu** screen, select the **Manual funct.** screen.
2. From the **Manual Functions** screen, select the **Pump** screen.
3. Press **Enter**.
4. Adjust the flow rate.
5. Press **Enter** or **Escape** to stop the pump.



## 6.2 Daily

Clean the machine every day after you finish working, as any electrolyte residue in the polishing cell can affect subsequent preparations.

### Polishing unit

Rinse the polishing cell and pump thoroughly with water before you fill any new electrolyte and at the end of each working day.



**WARNING**

Never use acetone or similar solvents.



**CAUTION**

Never turn the polishing unit upside down, particularly if there is electrolyte in the pump.



**Note**

Never leave the machine filled with electrolyte for longer periods of time, as this can cause the submerged parts to corrode.



**Note**

Make sure that the motor housing never comes in contact with the electrolyte.



**Note**

If you have been working with copper or copper alloys, some copper can have deposited on the cathodes. Remove it using a few drops of nitric acid before rinsing.

1. From the **Main menu** screen, select the **Manual funct.** screen.
2. From the **Manual funct.** screen, select the **Pump** screen. See [Operating the pump manually ▶ 27](#).
3. Start the pump and set the flow rate to 50.
  - Make sure that the flow from the jets is equal and that there are no blockages.
  - If you detect any blockage or leak, stop the pump and clean the jets thoroughly before restarting the pump.
  - Repeat until the flow from the jets is satisfactory.
  - Stop the pump.
4. Place a specimen holder in the polishing chamber.
5. Follow the instructions for cleaning: See [Cleaning ▶ 28](#).
6. When the cleaning program is finished, clean all accessible surfaces with a damp cloth, including the inside of the electrolyte container.
7. Wash all the used specimen holders thoroughly.

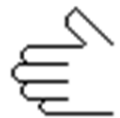

#### 6.2.1 Cleaning

When you have finished using the machine, you must clean the system.

**CAUTION**

Always use goggles or a protective shield, and chemical-resistant gloves.

**WARNING**

Do not touch, move or tamper with the unit during use.

1. From the **Main menu** screen, select the **Manual funct.** screen.



2. From the **Manual Functions** screen, select the **Cleaning** screen.



3. Press **Enter** to continue.



4. Follow the on-screen instructions. The on-screen instructions are listed below.

5. Press **Enter** to continue through the sequence of steps.



You can cancel the process at any time. To do so, press **Escape**.



6. The following messages appear.

**[ Remove Electrolyte: ]**

1. **Lift the polishing unit.**
2. **Place it in the container with water**
3. **Remove the present elec.**

**[ Cleaning... ]**

**The system is being cleaned now.**

**Please wait 54s**

**[ Cleaning done ]**

1. **Lift the polishing table.**
2. **Use alcohol to remove water.**
3. **Clean off the remaining alcohol.**

**[ Remove water ]**

**Remove the water.**

### 6.2.2 Control unit

- Avoid spilling electrolyte on the cabinet or on the front plate of the control unit.
- Clean the front plate with a damp cloth after use.

## 6.3 Monthly

### Recirculation unit

See the Instruction Manual for this unit.



**Note**

Replace the cooling fluid immediately if you notice that it is infected by algae or bacteria.

### 6.3.1 Calibrating the pump

#### The first time the machine is switched on

The pump must be adjusted before it is used for the first time.

To start the pump adjustment procedure, carry out the following:

1. The first time you switch on the machine, the following message is shown:

**The pump must be adjusted.**

1. Insert the calibration holder in the polishing cell.
2. Place the black tube in the thermometer hole.
3. Connect the calibration holder.
4. Select **Adjust with tube**.
5. To continue with the pump adjustment procedure, see [Carrying out the adjustment ► 31](#) in this section.

#### Subsequent use

If the results are not correct, or if you cannot reproduce the results, adjust the pump.

This function calibrates the pump of the polishing unit and ensures that the flow rate settings in the Struers methods are correct.

1. Insert the calibration holder in the polishing cell.
2. Place the black tube in the thermometer hole.
3. Connect the calibration holder.
4. From the **Main menu** screen, select the **Configuration** screen.
5. Press **F4 - Adj. Pump**.
6. To continue with the pump adjustment procedure, see [Carrying out the adjustment ► 31](#) in this section.

### Carrying out the adjustment

The following message is shown:

#### Insert container

**Please insert a container filled with 1.5 litre water.**

**Add a drop of detergent.**

7. Fill the container with 1.5 liters of water.
8. Add one drop of detergent to release the surface tension of the water.
9. Press **Enter** to continue.

The following message is shown:

#### Insert tubes

**Insert jet holder with ascending tube, return tube and specimen holder with specimen.**

10. Do as instructed.
11. Press **Enter** to continue.
12. Select **Maximum pump flow**.
13. Press **Enter** to start the pump.
14. Adjust the water level to the upper mark. The maximum setting should be approx. 120.
15. Press **Enter** to save the value.
16. Select **Minimum pump flow**.
17. Adjust the water level to the lower mark. The minimum setting should be approx. 75.
18. Press **Enter** to save the value.
19. When you have completed the adjustment, press **Escape**.



## 6.4 Annually

The safety devices must be tested at least once a year.

### 6.4.1 Test the safety devices



**WARNING**

Do not use the machine with defective safety devices. Contact Struers Service.

**Protective cover**

The safety devices must be tested at least once a year.



**WARNING**

Do not use the machine with defective safety devices. Contact Struers Service.

**Procedure**

1. To inspect the protective cover and the work zone interlock, remove the protective cover including the work zone interlock.
2. Press Start.
3. Make sure that polishing does not start.



## 6.5 Spare parts

**Technical questions and spare parts**

If you have technical questions or when you order spare parts, state the serial number. The serial number is stated on the type plate of the unit.

For further information, or to check the availability of spare parts, contact Struers Service. Contact information is available on [Struers.com](http://Struers.com).



**Note**

Replacement of safety critical components must only be performed by a Struers engineer or a qualified technician (electromechanical, electronic, mechanical, pneumatic, etc.).



**Note**

Safety critical components must only be replaced by components with at least the same safety level.

## 6.6 Disposal



Equipment marked with a WEEE symbol contains electrical and electronic components and must not be disposed of as general waste.

Contact your local authorities for information on the correct method of disposal in accordance with national legislation.

For disposal of consumables and recirculation fluid, follow local regulations.



**Electrolytes**

Contact your local authorities for information on the correct method of disposal in accordance with national legislation.

**6.7 Service and repair**

We recommend that a regular service check be carried out yearly or after every 1500 hours of use.

When the machine is started up, the display shows information about total operation time and the machines service information.

After 1500 hours of operation time, the display will show a message reminding the user that a service check should be scheduled.

**Note**

Service must only be performed by a qualified technician (electromechanical, electronic, mechanical, pneumatic, etc.).  
Contact Struers Service.

**7 Troubleshooting****Control unit**

Error	Cause	Action
The supply voltage is too low.	The power supply voltage is too low compared to the voltage stated on the back of the control unit.	If needed, change the voltage setting. See <a href="#">Voltage ► 20</a> .
No electrical connection.	There is no connection to the polishing unit.	Make sure that the polishing unit is connected to the back of the control unit.
	Too little electrolyte in the electrolyte container.	Increase the amount of electrolyte in the container up to a maximum of 1.5 l.
Temperature is above max. limit.	The electrolyte temperature is above the preset limit.	Connect the device to tap water or an external cooling unit and wait until the temperature is below the specified limit.
The device is switched on but the display is blank.	The backlight of the display has been turned off.	Press any button to reactivate the backlight.

See also TenuPol-5 Control unit, Optimizing the results.

## 8 Technical data

### 8.1 Technical data - TenuPol-5

Subject	Specifications	
<b>Software and electronics</b>	Supplied from TenuPol-5 Control unit. See the Instruction Manual for this unit.	
<b>Power supply</b>	Supplied from TenuPol-5 Control unit. See the Instruction Manual for this unit.	
<b>Output: Voltage/Current</b>	Polishing	0-100 V (0.1 V steps)/2.5 A
<b>Safety standards</b>	See the Declaration of Conformity	
<b>Dimensions and weight</b>	Width	270 mm (10.6")
	Depth	180 mm (7.1")
	Height	276 mm (10.9")
	Weight	3.8 kg (8.4 lbs)
<b>Operating environment</b>	Surrounding temperature	5-40°C (41-104°F)
	Humidity	0-95 % RH non-condensing
<b>Storage and transport conditions</b>	Surrounding temperature	-25-55°C (13-113°F)
	Humidity	0-95 % RH non-condensing

### 8.2 Noise and vibration levels

<b>Noise level</b>	A-weighted sound emission pressure level at workstations	$L_{pA} = 55.4 \text{ dB(A)}$ (measured value) Uncertainty $K = 4 \text{ dB}$ Measurements made in accordance with EN ISO 11202
--------------------	--	---

<b>Vibration level</b>	N/A
------------------------	-----

### 8.3 Safety Circuit Categories/Performance Level

Safety Circuit Categories/Performance Level	
Work zone interlock	EN 60204-1, Stop category 0 EN ISO 13849-1, Category 1 PL c

## 8.4 Safety Related Parts of the Control System (SRP/CS)



### WARNING

Safety critical components must be replaced after a maximum lifetime of 20 years. Contact Struers Service.



### Note

SRP/CS (safety-related parts of a control system) are parts that have an influence on safe operation of the machine.



### Note

Replacement of safety critical components must only be performed by a Struers engineer or a qualified technician (electromechanical, electronic, mechanical, pneumatic, etc.). Safety critical components must only be replaced by components with at least the same safety level. Contact Struers Service.

Safety related part	Manufacturer/Manufacturer description	Manufacturer catalog no.	Electrical ref.	Struers catalog no.
Interlock switch circuit - Polishing unit	Schmersal Coded-magnet sensor	BNS33-11Z-2M	SS1	2SS00140
Interlock switch circuit - Polishing unit	Schmersal Coded-magnet (actuator) for sensor	BPS33	SS1	2SS00141
Interlock switch circuit - Polishing unit	Finder Power relay	62.32.9.024.4800	K1	2KL46680

## 8.5 Diagrams

If you wish to view specific information in detail, see the online version of this manual.

### 8.5.1 Diagrams - TenuPol-5

#### Control unit

See the Instruction Manual for this unit.

**Polishing unit**

Title	No.
TenuPol-5, Block diagram	15393051 A
TenuPol-5, Connection adapter	15393508 B

15393051 A

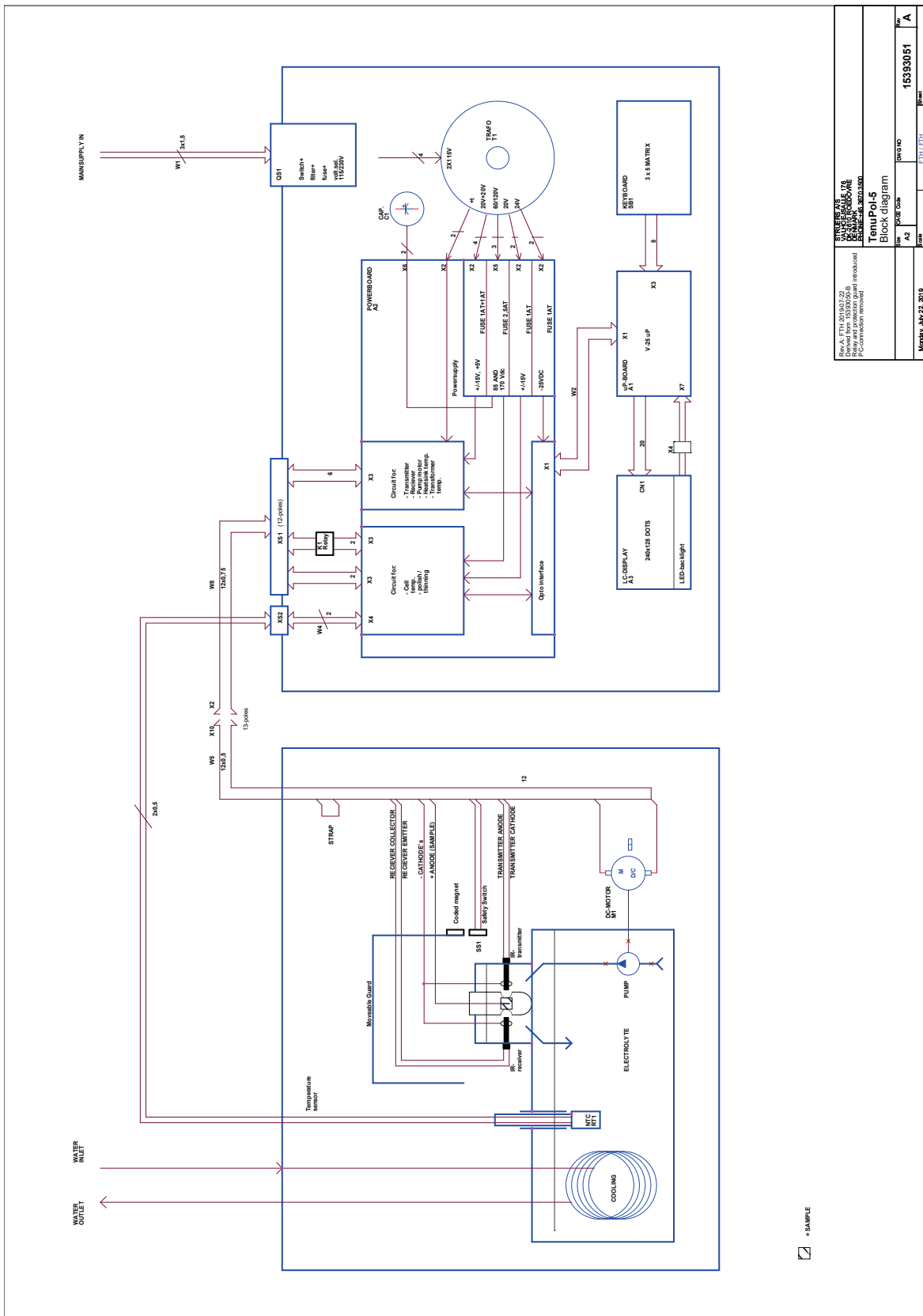

SWISSPAC SAUERLANDER AG Industriestrasse 10 4100 Birmensdorf Switzerland Tel: +41 (0) 44 711 21 22 E-mail: info@swisspac.ch www.swisspac.ch	
Derived from 15393051 B 15393051 A is a preliminary drawing (no commitment intended) (no guarantee intended)	
<b>TenuPol-5</b> Block diagram	
Rev	DATE
AZ	04.08.2019
Drawn	FINN/PH
Part	15393051
Page	1 of 1

15393508 B

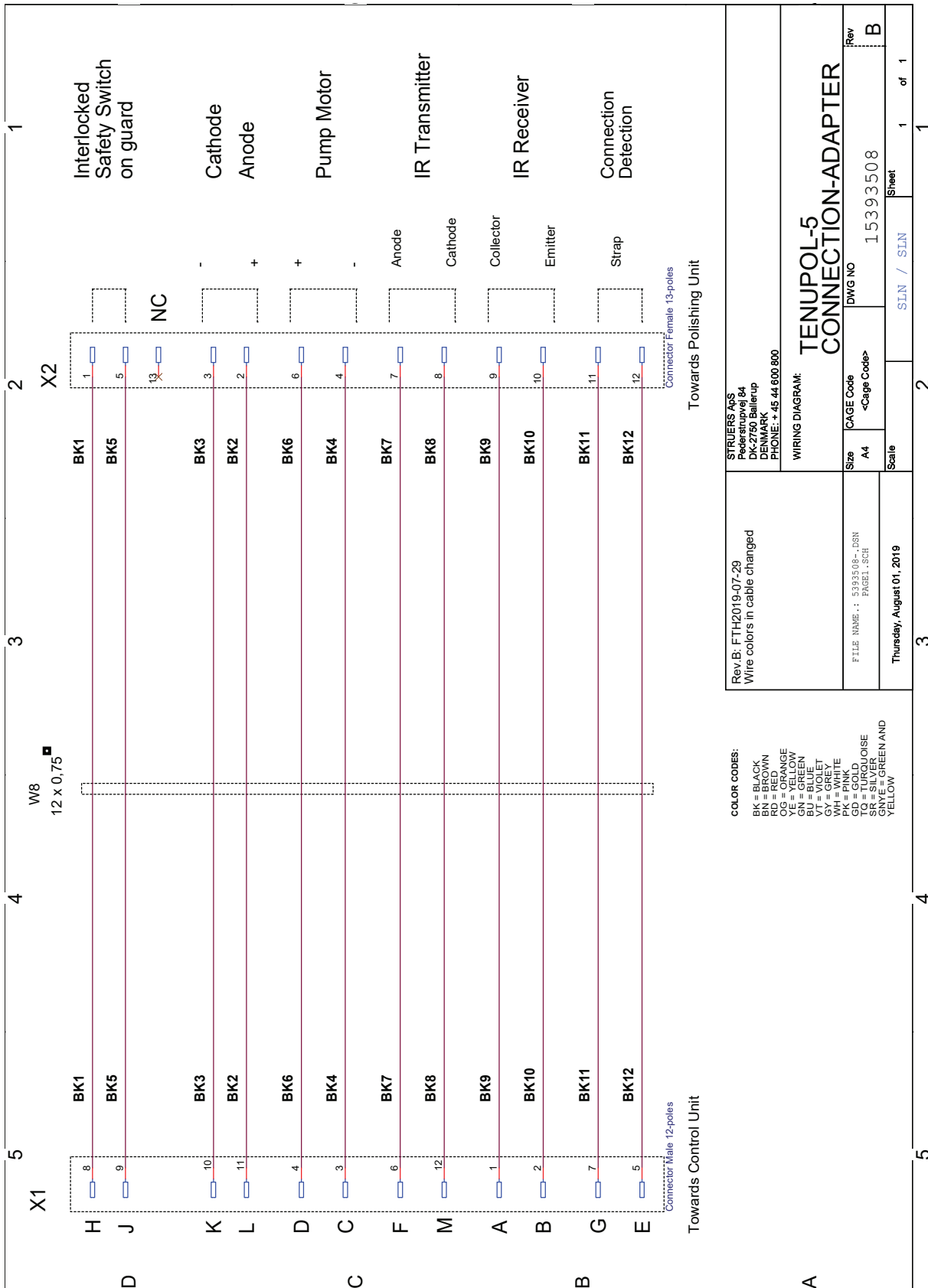

STRUERS Aps Pøstboksvej 64 2600 Ballerup DENMARK PHONE: + 45 44 600 800		Rev.B: FTH2019-07-29 Wire colors in cable changed	
WIRING DIAGRAM: Size A4 CAGE Code <Cage Code>		FILE NAME: 5393508-.DSN PAGE1.SCH	
DWG NO 15393508		Thursday, August 01, 2019	
Scale	SLN / SLN	Sheet	1 of 1

- COLOR CODES:**
- BK = BLACK
  - RD = RED
  - GR = GREEN
  - OG = ORANGE
  - YE = YELLOW
  - BL = BLUE
  - VI = VIOLET
  - GRY = GREY
  - PK = PINK
  - GD = GOLD
  - BR = BROWN
  - SR = SILVER
  - GNYE = GREEN AND YELLOW

## 8.6 Legal and regulatory information

### FCC notice

This equipment has been tested and found to comply with the limits for a Class B digital device, pursuant to part 15 of the FCC Rules. These limits are designed to provide reasonable protection against harmful interference in a residential installation. This equipment generates, uses and can radiate radio frequency energy and, if not installed and used in accordance with the instructions, may cause harmful interference to radio communications. However, there is no guarantee that interference will not occur in a particular installation. If this equipment does cause harmful interference to radio or television reception, which can be determined by turning the equipment off and on, the user is encouraged to try to correct the interference by one or more of the following measures:

- Reorient or relocate the receiving antenna.
- Increase the separation between the equipment and receiver.
- Connect the equipment into an outlet on a circuit different from that to which the receiver is connected.

## 9 Manufacturer

Struers ApS  
Pederstrupvej 84  
DK-2750 Ballerup, Denmark  
Telephone: +45 44 600 800  
Fax: +45 44 600 801  
[www.struers.com](http://www.struers.com)

### Responsibility of the manufacturer

The following restrictions should be observed, as violation of the restrictions may cause cancellation of Struers legal obligations.

The manufacturer assumes no responsibility for errors in the text and/or illustrations in this manual. The information in this manual is subject to change without notice. The manual may mention accessories or parts not included in the supplied version of the equipment.

The manufacturer is to be considered responsible for effects on safety, reliability, and performance of the equipment only if the equipment is used, serviced, and maintained in accordance with the instructions for use.





# Declaration of Conformity

Manufacturer	Struers ApS • Pederstrupvej 84 • DK-2750 Ballerup • Denmark
Name	TenuPol-5 Polishing unit
Model	N/A
Function	Polishing unit for TenuPol-5, Electrochemical thinning
Type	408
Cat. no.	04086002 TenuPol-5 Polishing unit in combination with 05396233 TenuPol-5Control unit
Serial no.	



Module H, according to global approach



We declare that the product mentioned is in conformity with the following legislation, directives and standards:

<b>2006/42/EC</b>	EN ISO 12100:2010, EN ISO 13849-1:2015, EN ISO 13849-2:2012
<b>2011/65/EU</b>	EN IEC 63000:2018
<b>2014/30/EU</b>	EN 61000-3-2:2014, EN 61000-3-3:2013, EN 61000-6-1:2007, EN 61000-6-3:2007, EN 61000-6-3-A1:2011, EN 61000-6-3-A1-AC:2012
<b>Additional standards</b>	NFPA 70, NFPA 79, FCC 47 CFR Part 15 Subpart B

Authorized to compile technical file/  
Authorized signatory

Date: [Release date]

en For translations see  
bg За преводи вижте  
cs Překlady viz  
da Se oversættelser på  
de Übersetzungen finden Sie unter  
el Για μεταφράσεις, ανατρέξτε στη διεύθυνση  
es Para ver las traducciones consulte  
et Tõlked leiate aadressilt  
fi Katso käännökset osoitteesta  
fr Pour les traductions, voir  
hr Za prijevode idite na  
hu A fordítások itt érhetőek el  
it Per le traduzioni consultare  
ja 翻訳については、  
lt Vertimai patalpinti  
lv Tulkojumus skatīt  
nl Voor vertalingen zie  
no For oversettelser se  
pl Aby znaleźć tłumaczenia, sprawdź  
pt Consulte as traduções disponíveis em  
ro Pentru traduceri, consultați  
se För översättningar besök  
sk Preklady sú dostupné na stránke  
sl Za prevode si oglejte  
tr Çeviriler için bkz  
zh 翻译见

[www.struers.com/Library](http://www.struers.com/Library)